

THINK FLEX- IBLE

RAYSAN

Flexible Barrier
POLYGUARD
PuffyGuard

3R COLUMN BARRIER + KERB

TECHNICAL DATA SHEET

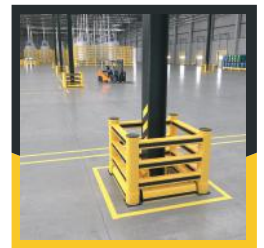

PRODUCT SPECIFICATIONS

MODEL	Post Dimension [D1]	Rail Dimension [D2]	Post Height [H1]	Rail Height [H2]	Ring Height [H3]	Rail Length [L1]	Rail Length [L2]	Column [C1]	Column [C2]	Impact Zone [Z]
ZETA	Ø160mm / Ø6.29"	100x100mm 3.93x3.93"	870mm / 34.25"	200mm / 7.87"	150mm / 5.90"	L1=C2+A+60	L2=C1+B+60	MIN300mm / 11.81" MAX1500 / 59.05"	MIN300mm / 11.81" MAX1500 / 59.05"	600mm / 23.62"
TETA	Ø125mm / Ø4.92"	50x100mm 1.96x3.93"	870mm / 34.25"	200mm / 7.87"	150mm / 5.90"	L1=C2+A+60	L2=C1+B+60	MIN300mm / 11.81" MAX1500 / 59.05"	MIN300mm / 11.81" MAX1500 / 59.05"	600mm / 23.62"

MODEL	Plate Dimension [A]	Plate Dimension [B]	Plate Thickness [T]	Fixations [M]
ZETA	190mm / Ø7.48"	190mm / Ø7.48"	10mm / 0.39"	M12x125 / M0.47x4.92"
TETA	160mm / Ø6.29"	160mm / Ø6.29"	6mm / 0.23"	M12x125 / M0.47x4.92"

BASE PLATES



ELECTROSTATIC PAINT



STAINLESS STEEL



GALVANIZE

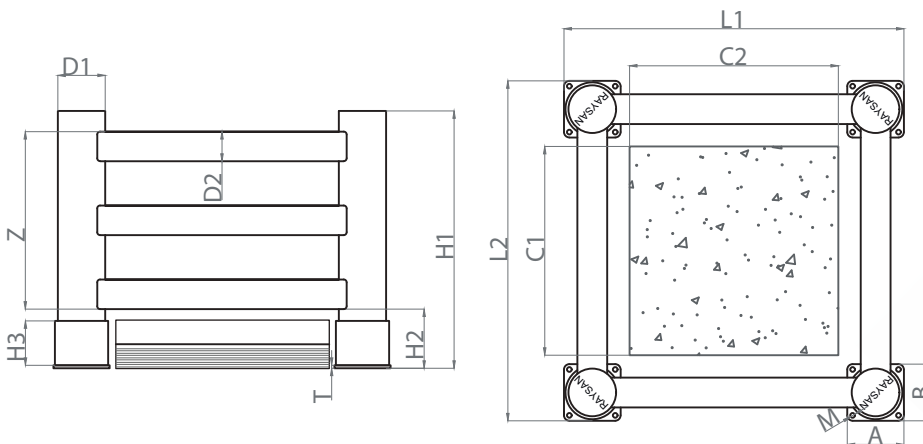

STANDARD COLOURS

RAL 1018 Pantone 123C

RAL 9005 Pantone B6C

*Please note that the RAL and PANTONE colours listed are the closest match to standard RAYSAN colours, but may not be exact matches of the actual product colour and should be used for guidance only.



FACTORY 1 Karadenizliler Mah. Kaldırım Sok. No: 12, 41140 Kocaeli / TÜRKİYE FACTORY 2 Vezirçiftliği Mah. Yalkım Sok. No:12, 41140 Kocaeli / TÜRKİYE

(+90) 216 223 00 23 | info@raysan.com | www.raysan.com